

The Core Family

Welcome to the Core line of fixtures. You will find a rich diversity of technical and aesthetic options including 3 trim apertures, over 14 finishes including custom wood trims, flux and source selections featuring 90+ CRI fixed white and our world class Ambient Dim (Warm Dim), multiple beam spreads and plethora of driver and control choices. The Core downlight is created on a platform allowing high degree of modification, so if you don't see what you are looking for, just ask. We are here to make your project right.

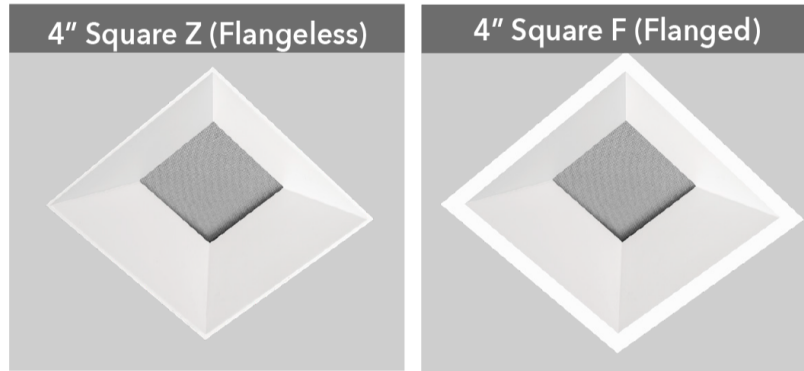

Deep Regress Shown

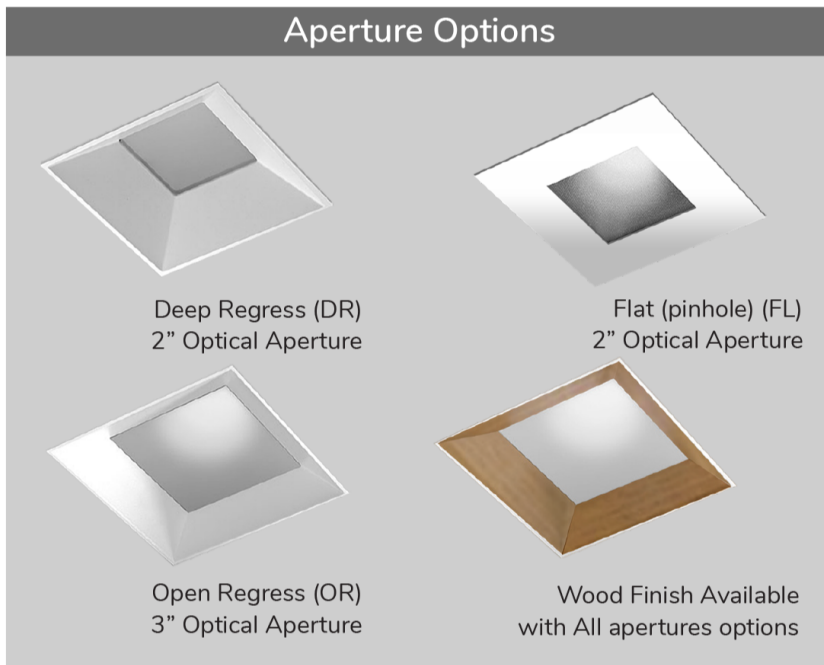
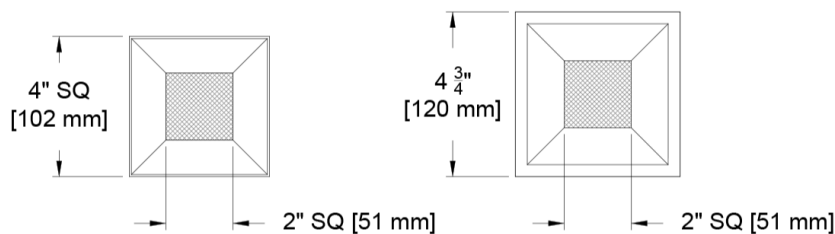

PROJECT:

TYPE:

SPECIFIER:

DATE:

Key Points (CR4D-SF)



Trim

- Flanged or Flangeless
- Flangeless includes plaster flange with lip
- 14 color options + custom RAL or wood available
- One-piece die cast aluminum or machined wood trim

Source / Optics

- 2700K, 3000K, 3500K, 4000K
Ambient Dim, RGBW & Tunable White options
- 90 CRI, 60+ R9 Standard- 95 CRI 90+R9 Optional with Ambient Dim
- <2 MacAdam Steps (<2SDCM) for fixed white
- Up to 2100 delivered lumens
- 4 beamspreads available- 15°, 24°, 40°, and 55°

Housing

- Heavy gauge aluminum for new construction or remodel
-  Compliant to  with Airtight Housing
-  Listed – Damp or wet with shower trim
- Approved for 8 (4-in / 4-out) #12 AWG conductors rated for 90°C through wiring
- IC Rated / Airtight Housing approved for use in direct contact with insulation – Chicago Plenum Available

Driver

- TruPhase™, 0-10, DALI-2, DMX, Ecosystem or Wireless Control
- Flicker free to IEEE 1789-2015 available with EldoLED and TruPhase™ selections
- Prewired and integral to housing
- Universal 120-277v

Ordering Codes

PROJECT:

SPECIFIER:

DATE:

TYPE:

QUANTITY:

Ordering Code Example: CR4D-SF-DR-Z-AU-C20-35-24-E2-P16-91A-91L-97L-CP

FIXTURE	APERTURE	TRIM	MOUNTING	SOURCE / WATTS	CCT	BEAM	DRIVER / CONTROL	TRIM FINISH	LENS ACCESSORIES	ACCESSORIES
CR4D-SF										
Core 4" Square Fixed Downlight	DR Deep Regress	Flanged Trims	Flanged Housings	Citizen	24 2400K	15 Spot	C1 0-10 1.0%, UNV (120-277V) linear	W White Paint	Aperture Lens	CP Chicago Plenum
	OR Open Regress	F Flanged Trim	U Universal - Non IC Housing	C14 ●● 15W 995Lm** 90+CRI, 60+R9	30 3000K	24 Narrow Flood	C2 ELV/Triac 1.0%, (120V) linear	B Black Paint	91A Solite	EM Emergency Pack
	FL Flat (Pin Hole)	FS Flanged Shower Trim* <i>(for mounting choose from Flanged Housings)</i>	AU ●● Airtight Universal IC-Rated	C20 ●● 21W 1326Lm** 90+CRI, 60+R9	35 3500K	40 Flood	E1 0-10 0.1%, UNV (120-277V) log	D Wood*	93A Frosted	Controls
		Flangeless Trims	Flangeless Housings	C28 ●● 30W*† 1857Lm** 90+CRI, 60+R9	40 4000K	55 Wide Flood	E2 DALI-2 0.1%, UNV (120-277V) log	PXX Specialty Paint Color*	XXA Other Aperture Lens Treatments*	LR Lutron Wireless RF PowPak
		Z Flangeless Trim	P Plaster - Non IC	Tunable	27 2700K		E3 0-10 0.1%, UNV (120-277V) linear	C Custom/RAL Color**	Reflector (lamp) Media	ATH Lutron Athena Wireless Node <i>Must be used with E2 driver</i>
		ZS Flangeless Shower Trim* <i>(for mounting choose from Flangeless Housings)</i>	AP ●● Airtight Plaster IC-Rated	T9 10W 90+CRI, 60+R9 Tunable White	TW1840 1800-4000K Tunable White w/ E1, E2, E3, E4		E4^ DMX 0.1%, UNV (120-277V) Universal DMX Driver/Controller RGBW-DMX	P01-P15	91L Solite	CA Casambi Wireless BLE to be paired with driver
		* Aperture Lens Required	PM Panel Mount	T15 15W 90+CRI, 60+R9 Tunable White	TW2765 2700-6500K Tunable White w/ E1, E2, E3, E4		LD Digital Ecosystem 1.0%, UNV (120-277V) ECO Hi-Lume SoftOn/Fade-to-Black LDE1	Other reflector (lamp) media*	93L Frosted	
			APM ●● Airtight Panel Mount IC-Rated	T20 ●● 21W 90+CRI, 60+R9 Tunable White	RG1280 1200-8000K RGBW Dynamic Color Changing <i>*Requires E2 or E4</i>		TR2 TruPhase™ 0.1%, (120-120V) log Up to 20W Forward and Reverse compatible Phase Dimming Static White & Ambient Dim only	FINISH GUIDE LINK	97L Black Hexcel Louver	
			●● Supports California Title 24 compliance to JA8 Requirements <i>*Cannot be used with C28 Source</i>	RGBW 90+CRI, 60+R9	Ambient Dim™		* Not compatible with C28	WOOD TRIM GUIDE	XXL Other reflector (lamp) media*	
				A14 ●● 15W 656Lm 95+CRI, 90+R9	2722* 2700-2200K <i>*A14 Only</i>			LENS ACCESSORY VISUAL GUIDE LINK	1 piece of Media per opening (aperture or reflector) can be selected <i>*Refer to Lens Accessory Guide</i>	
				A20 ●● 21W 858Lm 95+CRI, 90+R9	3019 3000-1900K					
				●● California Title 24 Compliant to JA8 <i>* Requires Active Cooling and not compatible with IC/Airtight housing. Not compatible with L2 and LP drivers.</i>	3022* 3000-2200K <i>*A14 Only</i>					
				†Flat Aperture does not meet Title 24						
				+EldoLED driver selection required and will be supplied with 2 channel version						

Ceiling Cutouts and Dimensions

Deep Regress shown - other apertures are similar

Square Flangeless Housing

Plaster Mount (P/AP)

(CR4D-SF-DR-Z-P/AP)

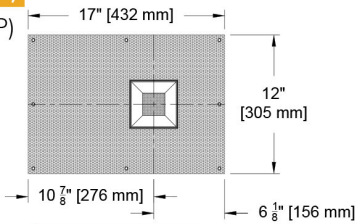
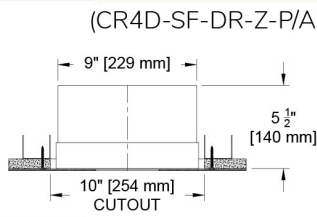
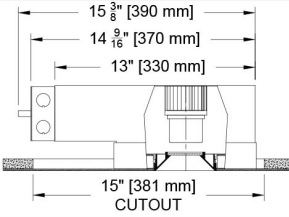

Square Flangeless Housing

Plaster Mount (P)

C28 Only*

(CR4D-SF-DR-Z-P-C28)

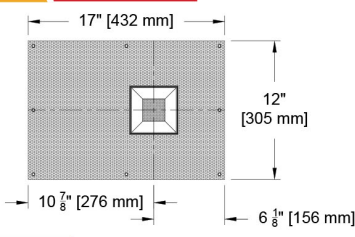
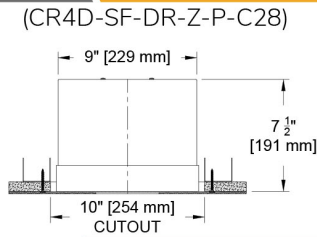
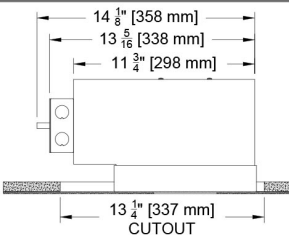

Square Flanged Housing

Flanged Mount (U/AU)

(CR4D-SF-DR-F-U/AU)

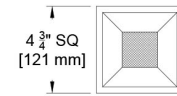
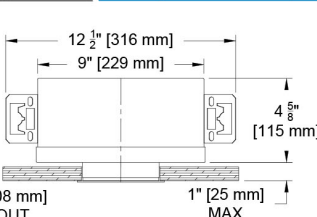
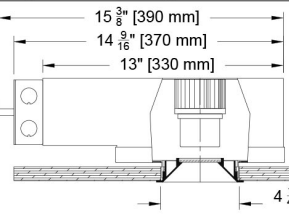

Square Flangeless Housing

Flangeless Mount (U/AU)

(CR4D-SF-DR-Z-U/AU)

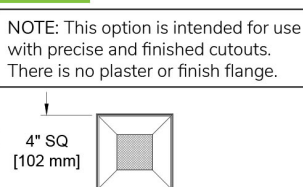
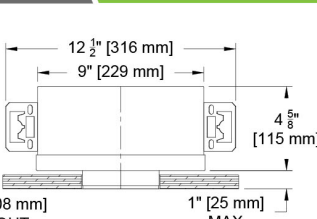
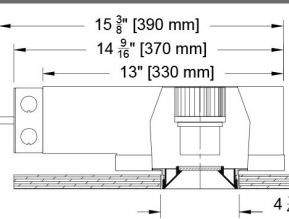

Square Flangeless Housing

Panel Mount (PM/APM)

(CR4D-SF-DR-Z-PM/APM)

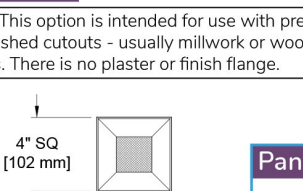
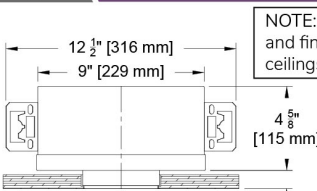
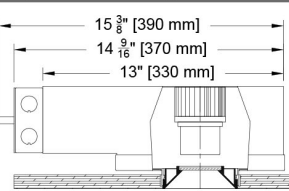

Square Universal Housing

(U) (PM)

C28 Only*

(CR4D-SF-DR-F/Z-U/PM-C28)

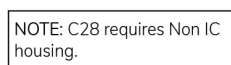
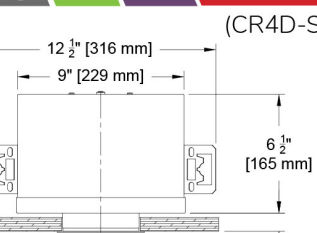
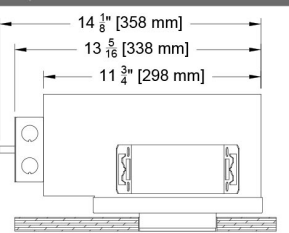

Hanger Bar Detail

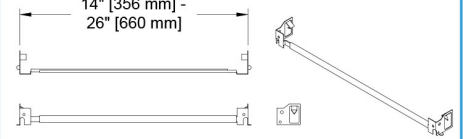
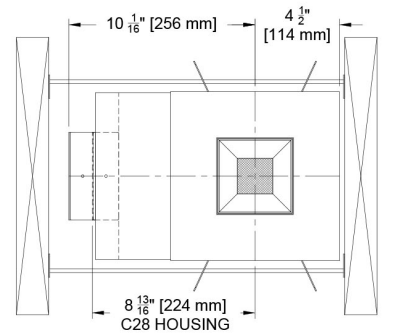
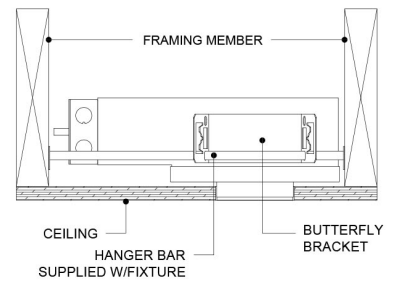

Panel Mount Detail

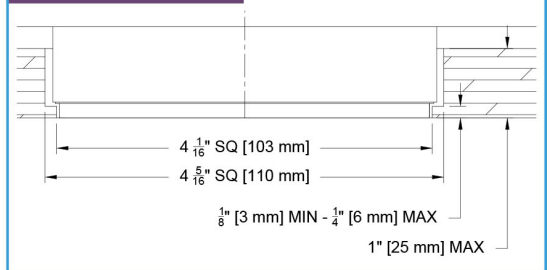

Photometric Table

All data is based from goniometer measurements of production representative product. All lumen values can vary +/- 10% from LED manufacturer rated flux range. Measurements at 3000 CCT

SQUARE Beamspreads		15°					24°					40°					55°				
Source	System watts (W)	Delivered Lumens (lm)	Lumens/Watt	Peak CD	10% Field	Delivered Lumens (lm)	Lumens/Watt	Peak CD	10% Field	Delivered Lumens (lm)	Lumens/Watt	Peak CD	10% Field	Delivered Lumens (lm)	Lms/Watt	Peak CD	10% Field				
Deep Regress	Citizen C14	15	1068	71	7642	42°	995	66	4174	46°	1037	69	3429	51°	996	66	1402	71°			
	Citizen C20	21	1424	68	10190	40°	1326	63	5562	39°	1382	66	4570	55°	1328	63	1870	73°			
	Citizen C28*	30	1848	62	13223	44°	1857	62	7791	47°	1916	64	6336	54°	1816	61	2556	69°			
	Ambient Dim A14	15	694	46	6220	43°	656	44	3189	44°	656	44	1827	53°	643	43	1028	70°			
Open Regress	Citizen C14	15	1173	78	7776	42°	1091	73	4167	52°	1112	74	2422	66°	1058	71	1357	74°			
	Citizen C20	21	1564	74	10369	41°	1455	69	5559	57°	1482	71	3199	63°	1411	67	1810	76°			
	Citizen C28*	30	2158	72	14306	44°	2008	67	7669	55°	2045	68	4455	67°	1947	65	2496	72°			
	Ambient Dim A14	15	810	54	5857	39°	779	52	3270	56°	779	52	1829	60°	764	51	1058	72°			
Flat (Pin Hole)	Citizen C14	15	829	55	7740	37°	737	49	1436	46°	719	48	2379	51°	661	44	1357	64°			
	Citizen C20	21	1105	53	10321	35°	982	47	5513	42°	958	46	3169	49°	881	42	1808	62°			
	Citizen CZ8*	30	1525	51	14258	32°	1355	45	7604	44°	1322	44	4375	53°	1216	41	2496	59°			
	Ambient Dim A14	15	539	36	4828	36°	479	32	2326	42°	467	31	1301	50°	429	29	689	63°			
CCT Multiplier																					
CCT	Citizen																				
2700	0.95																				
3000	1.00																				
3500	1.02																				
4000	1.03																				
All measurements based on 3000 CCT.																					

All Measurements delivered or derived delivered lumens based on 3000K. ISO CD plots based on Open Regress Ambient dim at full output. C28 source requires active cooling and must be used with NIC housing. Flat (Pin Hole) at wider beam angles experience significant beam clipping - refer to PDF report for exact FWHM beam angle.

Color Data

All data is based from goniometer measurements of production representative product. All values can vary +/- 10% from LED manufacturer rated data range. Measurements at 3000 CCT

Citizen Sources - C14, C20 and C28

- <2 MacAdam Ellipse (<2 SDCM)
- 90+ CRI and RF
- 60+R9, Hue Bin 1

94 CRI 70 R9

91 RF 100 RG

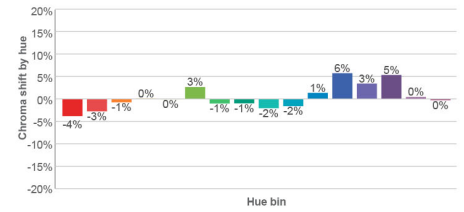
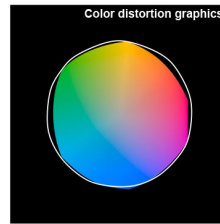
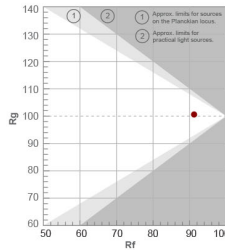
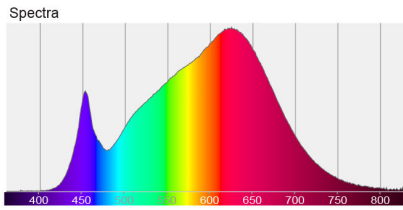
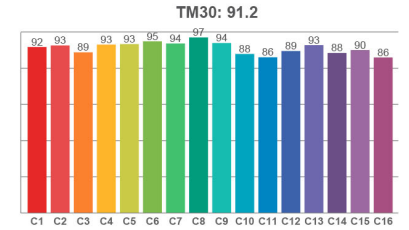
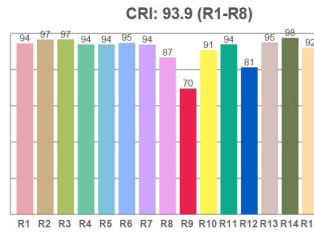

Ambient Dim - 3000k to 1900k

- <3 MacAdam Ellipse (<3 SDCM)
- 95+ CRI and RF
- 90+R9, Hue Bin 1
- Follows Black Body Locus through dimming range

3000 CCT Full Output

97 CRI 98 R9 95 RF 104 RG

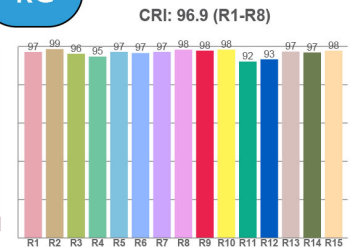
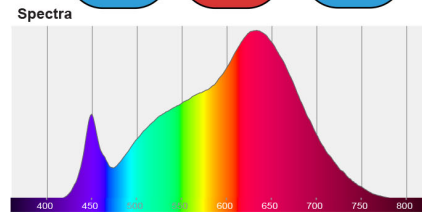

1850 CCT 5% Output

93 CRI 72 R9 83 RF 110 RG

